

Rotary Dampers

with high-torque range

WRD-H 0607

WRD-H 0805

WRD-H 1208

WRD-H 1610

WRD-H 2010



ONLINE
CALCULATION AND
2D / 3D CAD DOWNLOAD

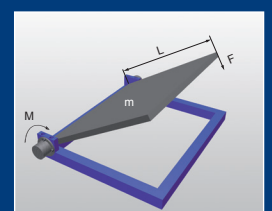

Benefits

Applications:

- Mechanical and plant engineering
- Vendingmachines, Counters
- Car industry and sanitary industry

Material:

- Aluminium and steel

Temperature:

- Standard: -10°C - +60°C

Deceleration:

- Controlled damping with rotary movements
- Torques up to 700 Nm
- Both sides, Right-turning and left-turning

RoHS-conform:

- Directive 2002/95/EC

Special models:

Stainless steel VA:

- Housing Stainless steel
V2A / DIN 1.4305 / AISI 303
- Piston rod special steel, chrome nitride coated

Applications:

- Food industry, Outside machinery,
Medical technology



R (CW)*	L (CCW)*	C*	M* (Nm)	Material*
WRD-H 0607-R	WRD-H 0607-L	WRD-H 0607-C	0,08	Aluminium / Steel
WRD-H 0805-R	WRD-H 0805-L	WRD-H 0805-C	0,2	
WRD-H 1208-R	WRD-H 1208-L	WRD-H 1208-C	1,1	
WRD-H 1610-R	WRD-H 1610-L	WRD-H 1610-C	2,6	
WRD-H 2010-R	WRD-H 2010-L	WRD-H 2010-C	3,5	

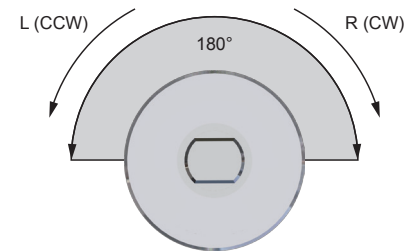
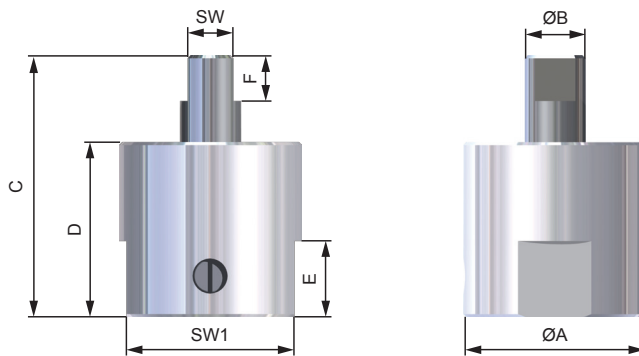

	ØA	ØB	C	D	E	F	SW	SW1
WRD-H 0607	9	3	18,7	13,0	4	2	2,6	8
WRD-H 0805	12	4	17,2	11,5	5	3	3	11
WRD-H 1208	18	5	20,6	15,5	5	3	4	15
WRD-H 1610	21	6	26	19	10	6	4	18
WRD-H 2010	24	6	25,0	18,0	10	6	4	22

Stainless steel

Clockwise	Anti-clockwise	Clockwise and anti-clockwise	Torque
			Nm
WRD-H 0805-R-VA	WRD-H 0805-L-VA	WRD-H 0805-C-VA	0,2
WRD-H 1208-R-VA	WRD-H 1208-L-VA	WRD-H 1208-C-VA	1,1
WRD-H 1610-R-VA	WRD-H 1610-L-VA	WRD-H 1610-C-VA	2,6
WRD-H 2010-R-VA	WRD-H 2010-L-VA	WRD-H 2010-C-VA	3,5
WRD-H 7550-R-VA	WRD-H 7550-L-VA	WRD-H 7550-C-VA	250
WRD-H 9565-R-VA	WRD-H 9565-L-VA	WRD-H 9565-C-VA	500
WRD-H 12070-R-VA	WRD-H 12070-L-VA	WRD-H 12070-C-VA	700

TORQUE

Clockwise	Anti-clockwise	Clockwise and anti-clockwise	Torque	Opening angle	Weight
			Nm	°	g
WRD-H 0607-R	WRD-H 0607-L	WRD-H 0607-C	0,08	180	4
WRD-H 0805-R	WRD-H 0805-L	WRD-H 0805-C	0,2	180	5
WRD-H 1208-R	WRD-H 1208-L	WRD-H 1208-C	1,1	180	14
WRD-H 1610-R	WRD-H 1610-L	WRD-H 1610-C	2,6	180	22
WRD-H 2010-R	WRD-H 2010-L	WRD-H 2010-C	3,5	180	27

Idle: At the beginning of the deceleration max. 5°

Important Information

Rotary dampers can not be used as end stop; external stop must be provided before the end of the stroke.

Temperature

WRD-H: -10 °C - +60 °C

Reference temperature for all technical information: 20°C
At a higher temperatures the energy absorption or torque is reduced.

Fix the rotary damper at the intended bores and flats. It is not allowed to loaded rotary dampers in a static way or to fix them by welding.

Rotary damper can not be used with aggressive fluids. Exception WRD-H...VA

Adjustment

If the mass in a trial run impacts excessively hard on the end position select the next model with higher torque for the series

WRD-H 0607, 0805, 1208, 1610 and 2010. If the mass don't reach the end position or the time is too long select the next model with lower torque for the series mentioned above. If the adjustment is not sufficient in an end position contact Weforma.

Rotary dampers should under no circumstance be loaded over the damping angle mentioned in the catalogue.

Fundamentals

Rotary dampers may under no circumstances be:

-painted



-welded



-held with clamps



The products must be protected against contamination, fluids and air pressure. We offer special solutions for these applications. When rotary dampers are used parallel the size of the model and the used degree of hardness / used adjustment has to be the same. The load has to be distributed equally. When a shock absorber is used for an emergency case, an external end stop must be provided. If the absorption should be insufficient, please contact Weforma or the respective representation. You will find further technical informations to the series in our catalogue.

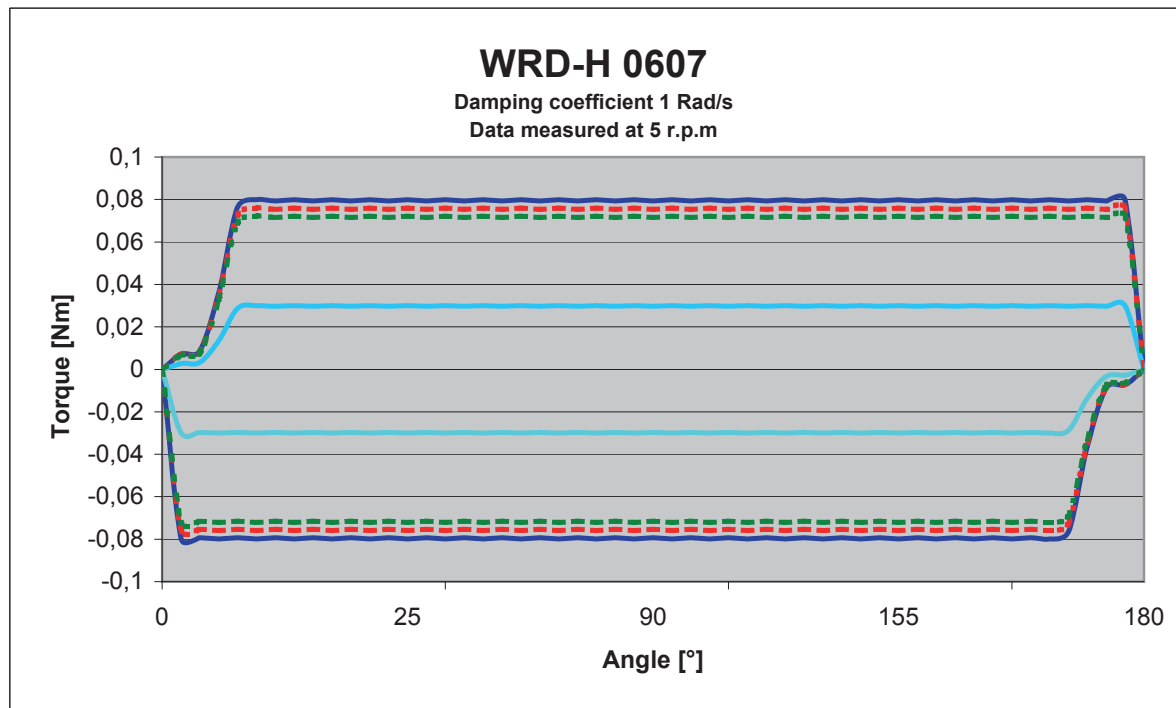

 Execution WRD-H 0607 C maximum damping in both directions at 20 ° C

 Execution WRD-H 0607 C maximum damping in both directions at 40 ° C

 Execution WRD-H 0607 C maximum damping in both directions at 60 ° C

 Execution WRD-H 0607 R maximum returndamping at 20 ° C

 Execution WRD-H 0607 L maximum returndamping at 20 ° C

Maximum angle 180°

Execution "R" and "L" only in one direction

The values may vary depending on the adjustment and the speed

This damper is non adjustable technische Änderungen

subject to technical changes

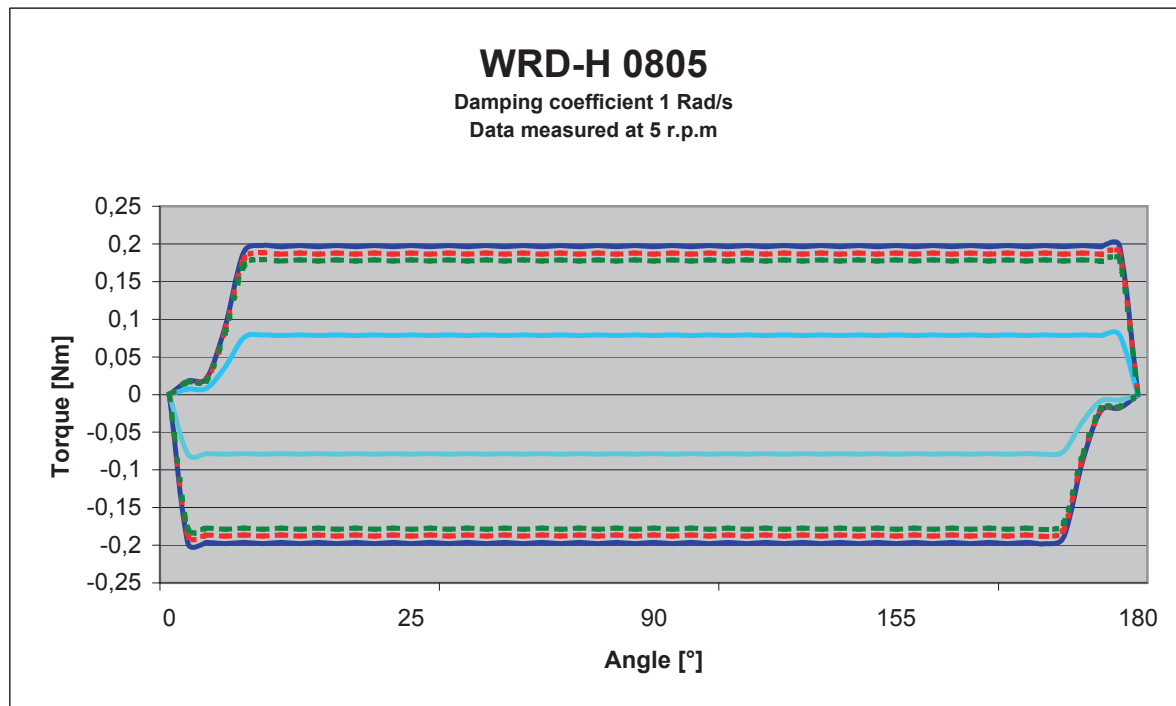

 Execution WRD-H 0805 C maximum damping in both directions at 20 ° C

 Execution WRD-H 0805 C maximum damping in both directions at 40 ° C

 Execution WRD-H 0805 C maximum damping in both directions at 60 ° C

 Execution WRD-H 0805 R maximum returndamping at 20 ° C

 Execution WRD-H 0805 L maximum returndamping at 20 ° C

Maximum angle 180°

Execution "R" and "L" only in one direction

The values may vary depending on the adjustment and the speed

This damper is non adjustable technische Änderungen

Subject to technical changes

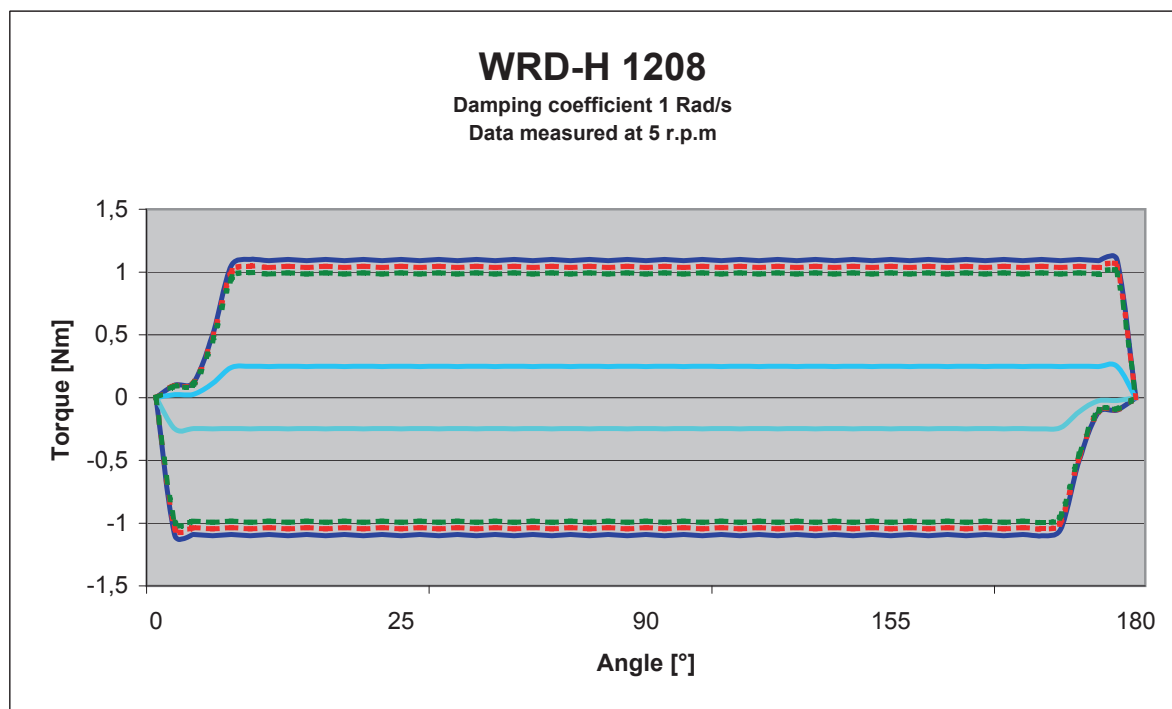

 Execution WRD-H 1208 C maximum damping in both directions at 20 ° C

 Execution WRD-H 1208 C maximum damping in both directions at 40 ° C

 Execution WRD-H 1208 C maximum damping in both directions at 60 ° C

 Execution WRD-H 1208 R maximum returndamping at 20 ° C

 Execution WRD-H 1208 L maximum returndamping at 20 ° C

Maximum angle 180°

Execution "R" and "L" only in one direction

The values may vary depending on the adjustment and the speed

This damper is non adjustable technische Änderungen subject to

Technical changes

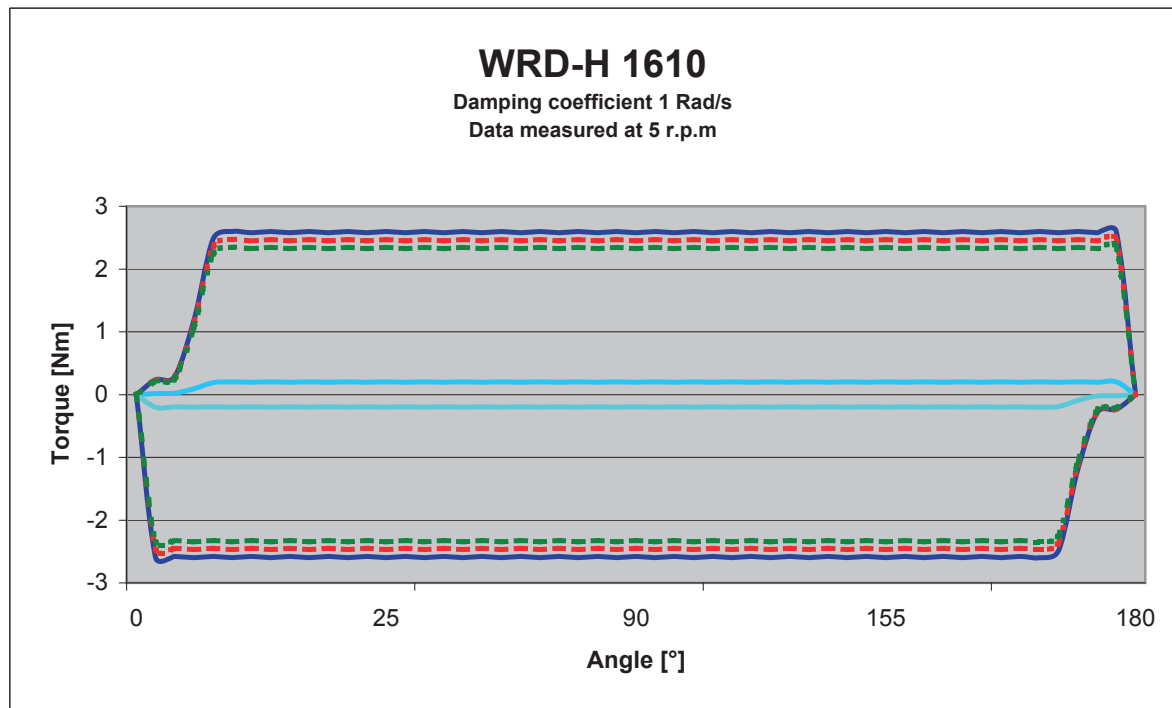

 Execution WRD-H 1610 C maximum damping in both directions at 20 ° C

 Execution WRD-H 1610 C maximum damping in both directions at 40 ° C

 Execution WRD-H 1610 C maximum damping in both directions at 60 ° C

 Execution WRD-H 1610 R maximum returndamping at 20 ° C

 Execution WRD-H 1610 L maximum returndamping at 20 ° C

Maximum angle 180°

Execution "R" and "L" only in one direction

The values may vary depending on the adjustment and the speed

This damper is non adjustable technische Änderungen subject to

Technical changes

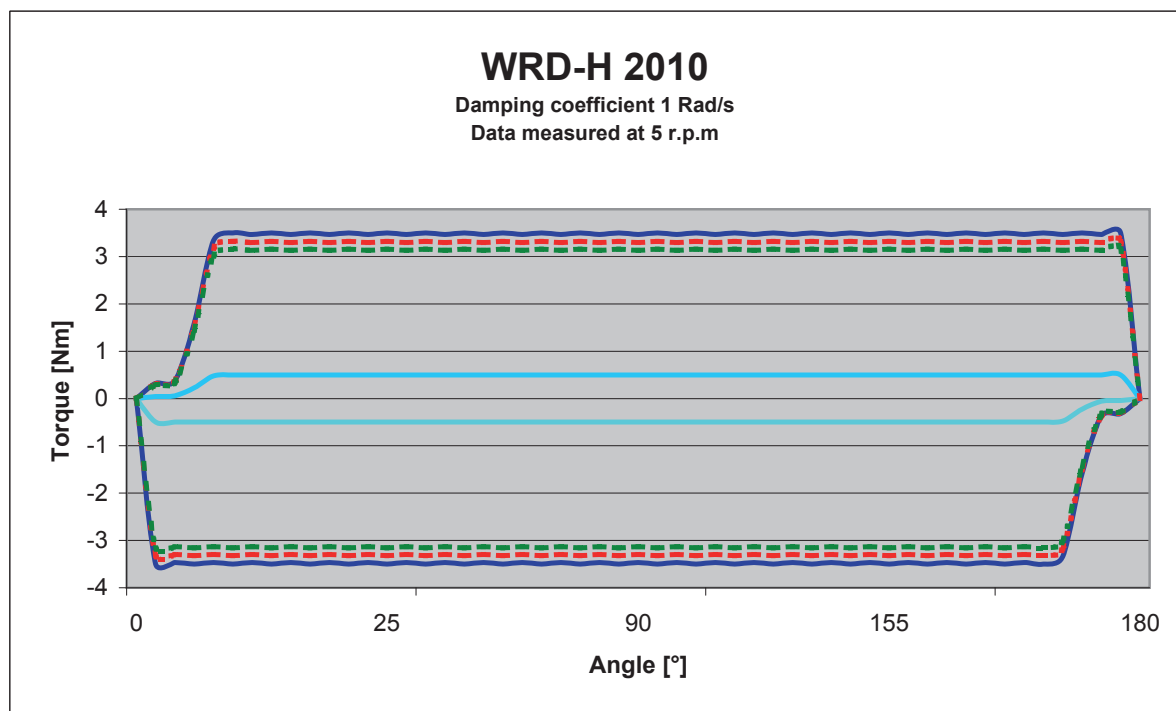

 Execution WRD-H 2010 C maximum damping in both directions at 20 ° C

 Execution WRD-H 2010 C maximum damping in both directions at 40 ° C

 Execution WRD-H 2010 C maximum damping in both directions at 60 ° C

 Execution WRD-H 2010 R maximum returndamping at 20 ° C

 Execution WRD-H 2010 L maximum returndamping at 20 ° C

Maximum angle 180°

Execution "R" and "L" only in one direction

The values may vary depending on the adjustment and the speed

This damper is non adjustable technische Änderungen subject to

Technical changes