

Escapements

WVE 32-50



ONLINE
2D / 3D CAD Download



Benefits

Housing	Anodised aluminium
Piston rod	Nickel plated
Compressed air	Oiled / oil-free
RoHS compliant	Directive 2002/95/EC

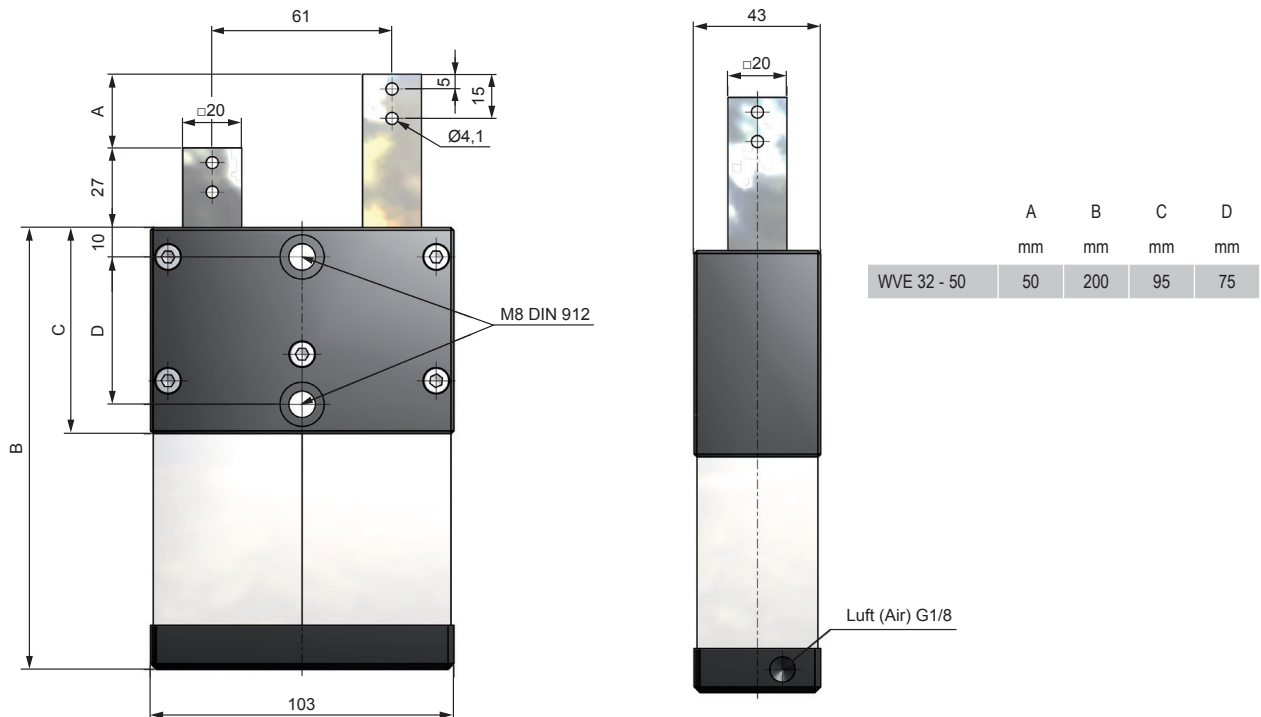

PERFORMANCE

	Stroke	Extension force	Retraction force	Working pressure	Max. lateral load without support	Working temperature	Weight
	mm	min. N	max. N	bar	Nm	°C	g
WVE 32-50	50	80	69	2 - 8	164	5 - 80	2400

Accessories

Ordering information proximity switch

Standard version: without preparation for proximity switch: WVE 32-50
 N* Version: with preparation for proximity switch WVE 32-50-N

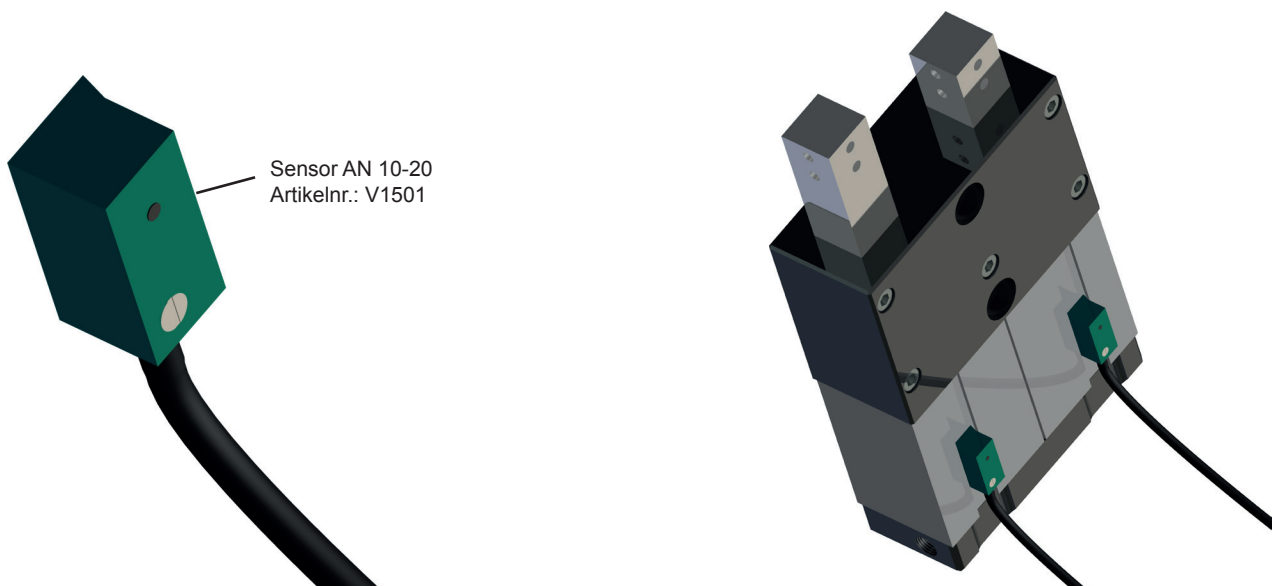

Working Principle

Position 1

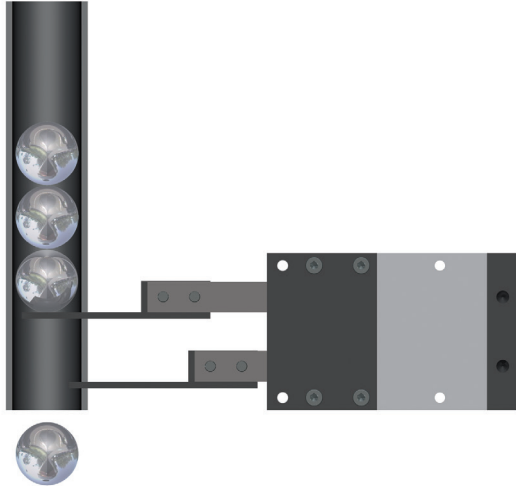

Position 2

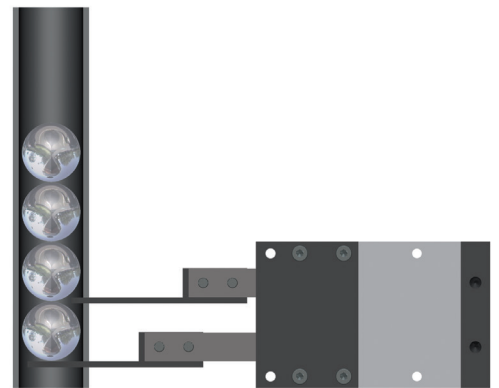
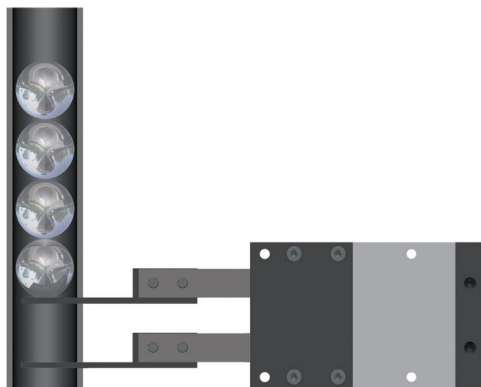

Position 3

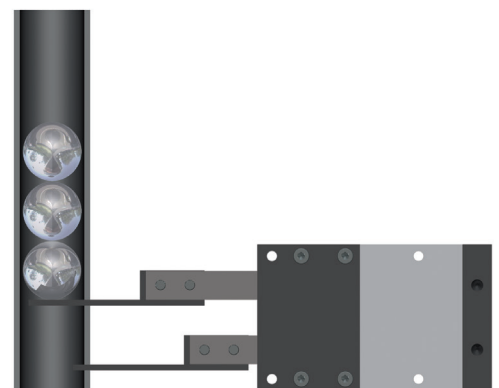
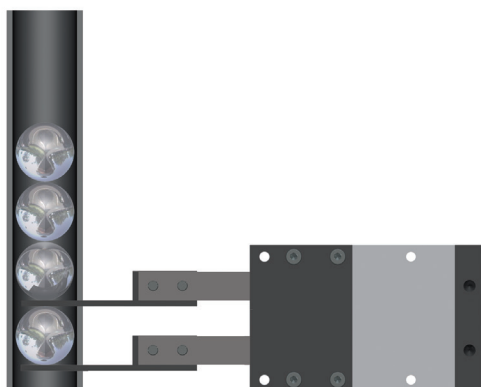

Circuit diagram

Proximity switch N10

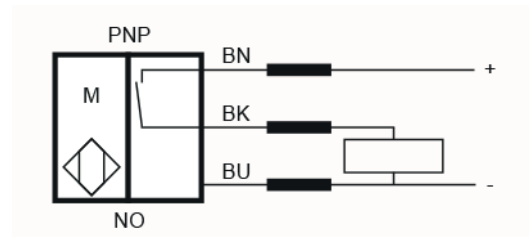

Proximity switch N11

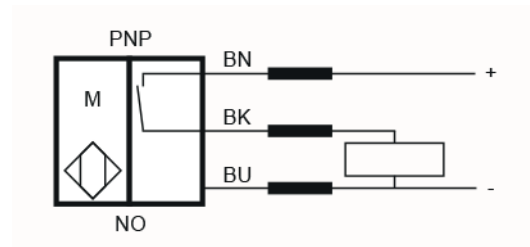

Proximity switch N15

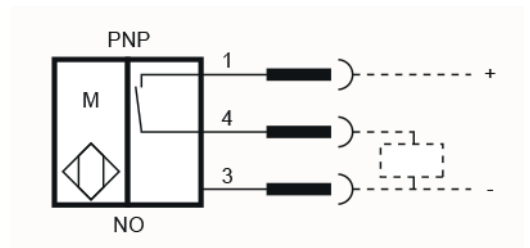

Proximity switch N16

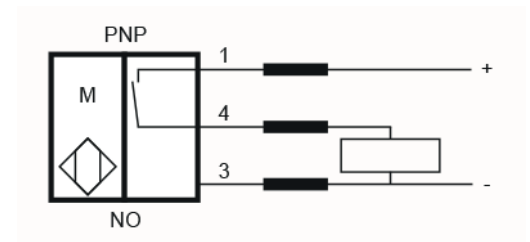

Proximity switch N20

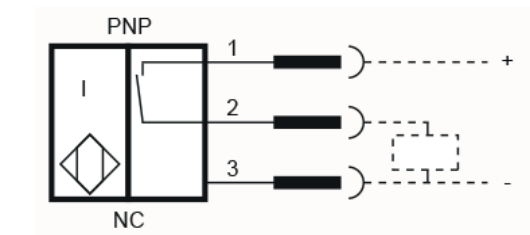

Safety Instructions

Attention

For all work on or with the Escapements WVE, the data sheet must be observed. The work must be performed by trained, skilled personal.

Electrical connections must be in accordance with VDE0100 or the relevant national regulations.

Repair and maintenance:

Electricity and compressed air must be shut down.

The work area is to prevent against accidentally switch on of electricity and compressed air.

Max. Load:

If several workpieces are dammed, it must be ensured that the total mass the workpieces the max. does not exceed allowable lateral load on the escapement.

Reference temperature for all technical information: 20°C

At a higher temperatures the energy absorption or torque is reduced.

Designated use

Stopping and positioning of one or more workpieces at the stop plate of the pallet.

The escapement WVE is designed for the separation of workpieces.

A load is permitted only in the working direction. The escapement WVE is not suitable for hazardous area. It is not allowed to use it as securing element without approval of Weforma.

The used position of the stop must be interrogated.

Liability - Guarantee

All warranty and liability claims expire at non-designated use.

This applies even if no original spare parts are used.

Environment protection

The replacement of worn parts must be paid to proper disposal.

Wearing parts and complete stopper can be sent to Weforma for free disposal.